

1A Surface Mount Glass Passivated Bridge Rectifier

Features

- Glass Passivated Chip Junction
- Reverse Voltage 100 to 1000 V
- Forward Current 1A
- High Surge Current Capability
- Designed for Surface Mount Application
- Lead free in comply with EU RoHS 2011/65/EU directives

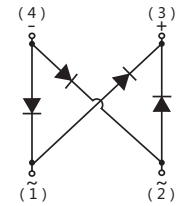
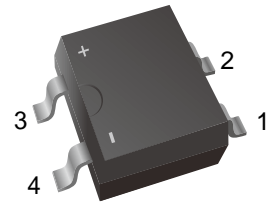

Mechanical Data

- Case : MBS
- Terminals: Solderable per MIL-STD-750, Method 2026

Ordering Information

Part Number	Shipping	Reel
LTM1B THRU LTM10B-TR3	3000PCS Tape&Reel	13 inches

Maximum Ratings and Electrical Characteristics

Ratings at 25 °C ambient temperature unless otherwise specified.

Single phase half-wave 60 Hz, resistive or inductive load, for capacitive load current derate by 20 %.

Parameter	Symbol	LTM1B	LTM2B	LTM4B	LTM6B	LTM8B	LTM10B	Unit
Maximum Repetitive Peak Reverse Voltage	V_{RRM}	100	200	400	600	800	1000	V
Maximum RMS voltage	V_{RMS}	70	140	280	420	560	700	V
Maximum DC Blocking Voltage	V_{DC}	100	200	400	600	800	1000	V
Average Rectified Output Current @ Fig.1	I_O	1.0						A
Peak Forward Surge Current 8.3 ms Single Half Sine Wave Superimposed on Rated Load (JEDEC Method)	I_{FSM}	35						A
Maximum Forward Voltage at 1.0 A	V_F	1.1						V
Maximum DC Reverse Current @ $T_A=25\text{ }^\circ\text{C}$ at Rated DC Blocking Voltage @ $T_A=125\text{ }^\circ\text{C}$	I_R	5 100						μA
Typical Junction Capacitance (Note1)	C_j	7						pF
Typical Thermal Resistance (Note2)	$R_{\theta JA}$ $R_{\theta JC}$ $R_{\theta JL}$	45 15 25						$^\circ\text{C/W}$
Operating and Storage Temperature Range	T_j, T_{stg}	-55 ~ +150						$^\circ\text{C}$

Note: (1) Measured at 1MHz and applied reverse voltage of 4 V D.C.

(2) Mounted on glass epoxy PC board 4X1.5" X 1.5" (3.81 cm X 3.81 cm) copper pad.

characteristics Curves

Fig.1 Average Rectified Output Current Derating Curve

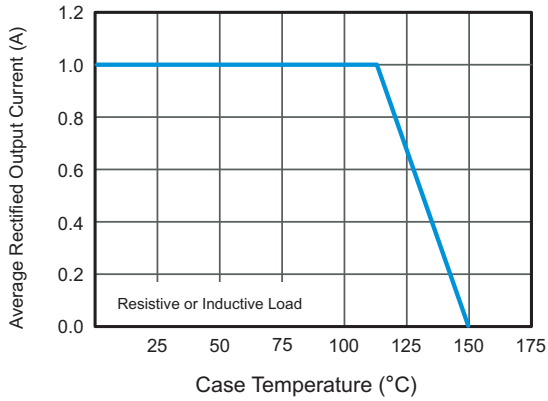

Fig.2 Typical Instantaneous Reverse Characteristics

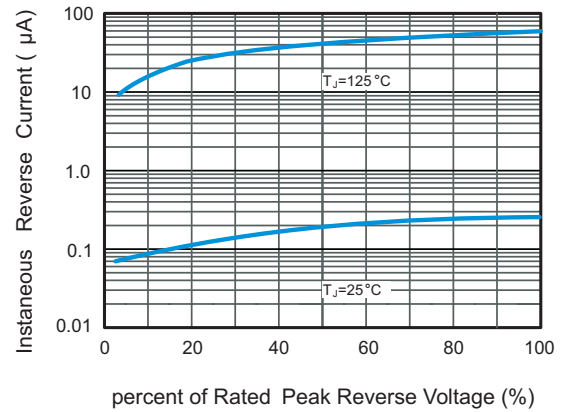

Fig.3 Typical Forward Characteristic

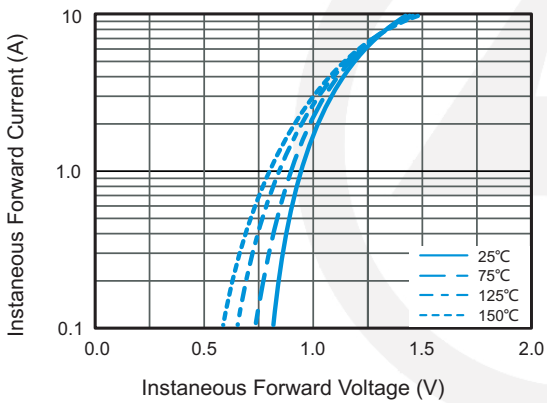

Fig.4 Typical Junction Capacitance

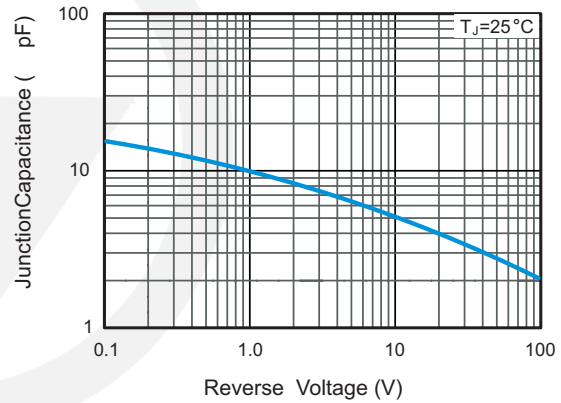
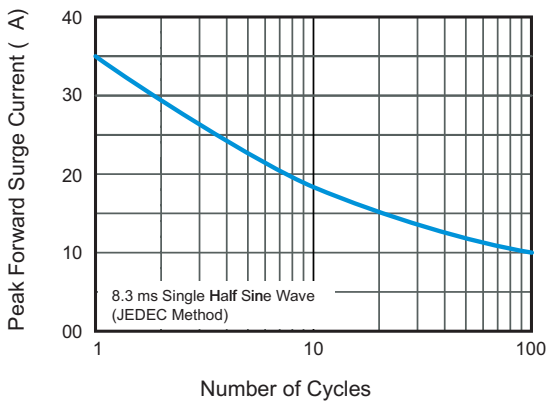
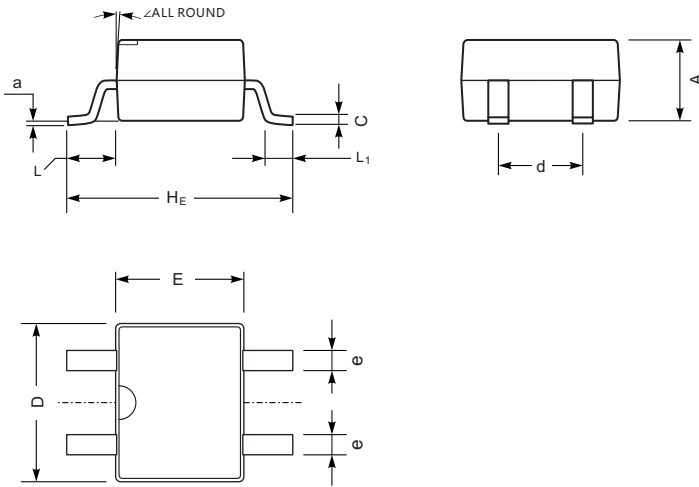

Fig.5 Maximum Non-Repetitive Peak Forward Surge Current



MBS Package Outline



Unit: mm

SYMBOL	DIMENSIONS	
	MIN.	MAX.
A	2.20	2.60
C	0.15	0.22
D	4.50	5.00
E	3.60	4.10
HE	6.40	7.00
d	2.30	2.70
e	0.50	0.70
L	1.30	1.70
L1	0.50	1.10
a	-	0.20
θ	7°	

MBS Suggested Pad Layout

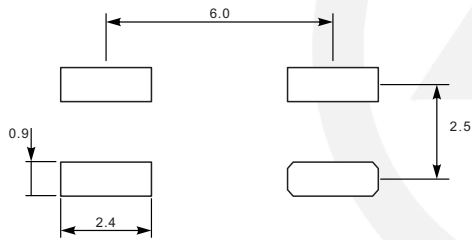

Note:

1. Controlling dimension: in millimeters.
2. General tolerance: $\pm 0.05\text{mm}$
3. The pad layout is for reference purpose only.

Marking

Type number	Marking code
LTM1B	MB1S
LTM2B	MB2S
LTM4B	MB4S
LTM6B	MB6S
LTM8B	MB8S
LTM10B	MB10S

Reel Dimensions

Unit : mm

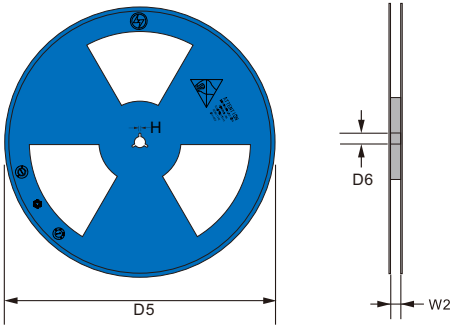
<p>13" Reel</p> 	D5	$\Phi 330.0 \pm 2.0$
	D6	$\Phi 13.5 \pm 0.5$
	H	2.5 ± 1.0
	W2	12 ± 2.0
	Quantity: 3000PCS	

Packaging

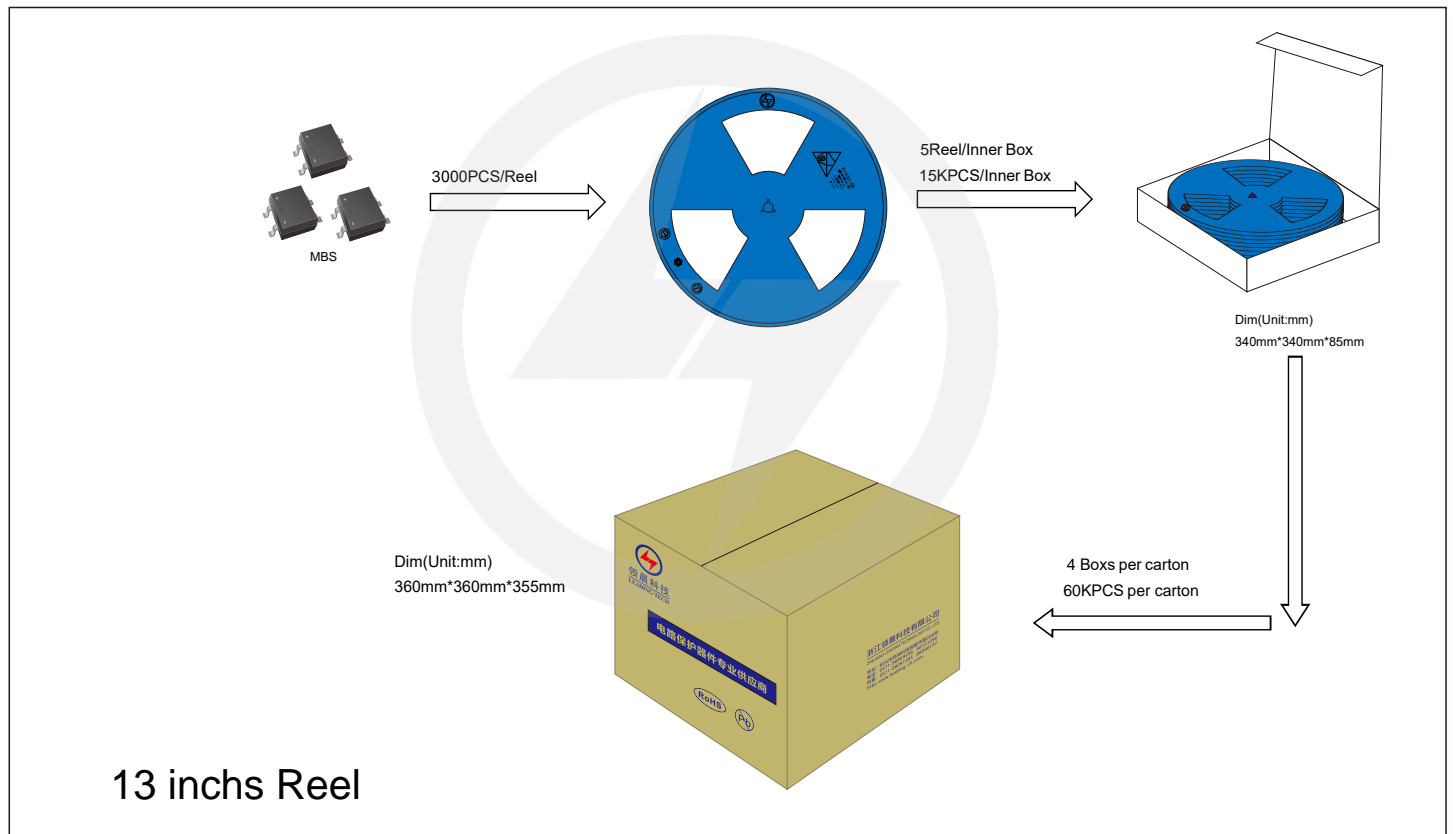



Recommended Soldering Conditions



Recommended Conditions

Profile Feature	Pb-Free Assembly
Average ramp-up rate (T _L to T _P)	3°C/second max.
Preheat	
-Temperature Min (T _{S min})	150°C
-Temperature Max (T _{S max})	200°C
-Time (min to max) (t _s)	60-180 seconds
T _{S max} to T _L	
-Ramp-up Rate	3°C/second max.
Time maintained above:	
-Temperature (T _L)	217°C
-Time (t _L)	60-150 seconds
Peak Temperature (T _P)	260°C
Time within 5°C of actual Peak Temperature (t _p)	20-40 seconds
Ramp-down Rate	6°C/second max.
Time 25°C to Peak Temperature	8 minutes max.

Important Notice and Disclaimer

Leading-Tech reverses the right to make changes to this document and its products and specifications at any time without notice.

Customers should obtain and confirm the latest product information and specifications before final design, purchase or use.

Leading-Tech makes no warranty, representation or guarantee regarding the suitability of its products for any particular purpose, not does Leading-Tech assume any liability for application assistance or customer product design.

Leading-tech does not warrant or accept any liability with products which are purchase or used for any unintended or unauthorized application.

No license is granted by implication or otherwise under any intellectual property rights of Leading-Tech.

Leading-Tech products are not authorized for use as critical components in life support devices or systems without express written approval of Leading-tech.

Version Update Information

Series NO.	Enactment/Revision Date	Effective Date	Version	Revision content	Revision Reason	Revision Person	Note
01	2024.12.19	2024.12.19	3.0	New File	/	Ding	