

Ultra Low Capacitance ESD Protection Device

Features

- Transient protection for high-speed data line
IEC 61000-4-2 (ESD) ±15kV (Contact)
IEC 61000-4-2 (ESD) ±15kV (Air)
Cable Discharge Event (CDE)
- Package optimized for high-speed line
- Ultra-small package(0.6mm x 0.3mm x 0.2mm)
- Working voltage: 3.3V
- Snap back featured
- Low capacitance: 0.22pF (Typical)
- Low leakage current
- Low clamping voltage
- Lead free in comply with EU RoHS 2011/65/EU directives

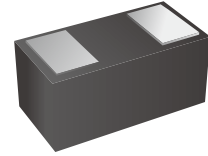

Mechanical Data

- Case:CSP0603
- Flammability Rating: UL 94V-0

Applications

- USB 3.x
- MHL 2.0
- SATA/SAS
- PCI Express
- RF Antenna

Ordering Information

Part Number	Marking	Shipping	Reel
LTE06N03C01LBU-TR10	H	10000PCS Tape&Reel	7 inches

Absolute Maximum Ratings

Symbol	Parameter	Value	Unit
V _{ESD}	ESD per IEC 61000-4-2 (Contact)	±15	kV
	ESD per IEC 61000-4-2 (Air)	±15	
P _{PP}	Peak Pulse Power (8/20μs)	66	W
I _{PP}	Peak Pulse Current (8/20μs)	9	A
T _{OPT}	Operating Temperature	-50~125	°C
T _{STG}	Storage Temperature	-55~150	°C

Electrical Characteristics (T_{amb}=25°C)

Symbol	Parameter	Test Condition	Min	Typ	Max	Unit
V _{RWM}	Reverse Working Voltage	Pin to Pin			3.3	V
V _{BR}	Reverse Breakdown Voltage	I _T = 1mA	5	5.8		V
I _R	Reverse Leakage Current	V _{RWM} = 3.3V		1	100	nA
V _H	Holding Reverse Voltage	Pin to Pin		2.1		V
I _H	Holding Reverse Current	Pin to Pin		38		mA
V _C	Clamping Voltage	I _{PP} = 1A, t _p = 8/20μs		2.5	5	V
		I _{PP} = 9A, t _p = 8/20μs		5.8	7.4	V
V _{CTL P}	TLP Clamping Voltage	TLP I _{PP} = 8A, t _p = 100ns		4.5		V
		TLP I _{PP} = 16A, t _p = 100ns		6		V
R _{DYN}	Dynamic Resistance	I _{TLP} = 4A to I _{TLP} = 16A		0.19		Ω
C _J	Junction Capacitance	V _R = 0V, f = 1MHz		0.22	0.26	pF



Characteristic Curves

Fig.1 Clamping Voltage vs Peak Pulse Current

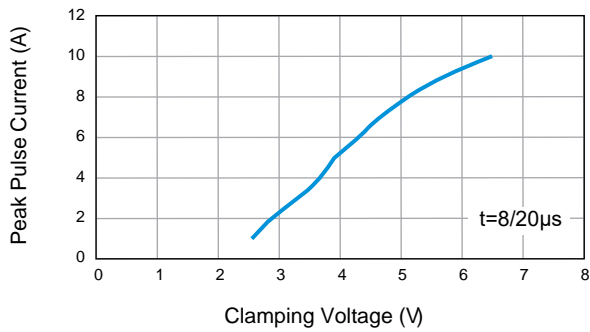

Fig.2 Voltage vs Capacitance

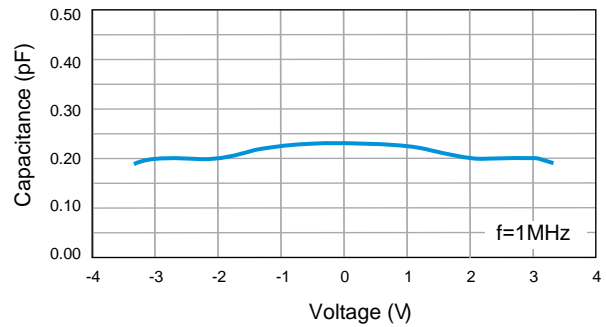

Fig.3 Transmission Line Pulsing (TLP)

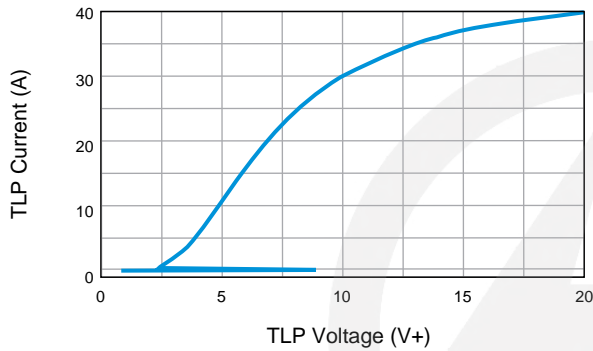

Fig.4 Transmission Line Pulsing (TLP)

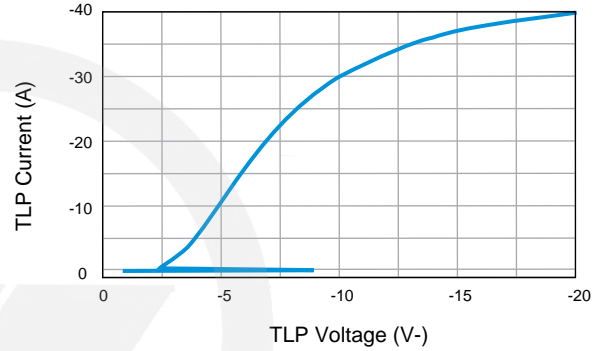

Fig.5 ESD Clamping of I/O to GND (+8kV Contact per IEC 61000-4-2)

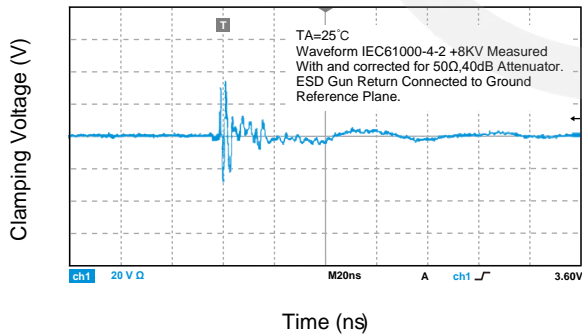
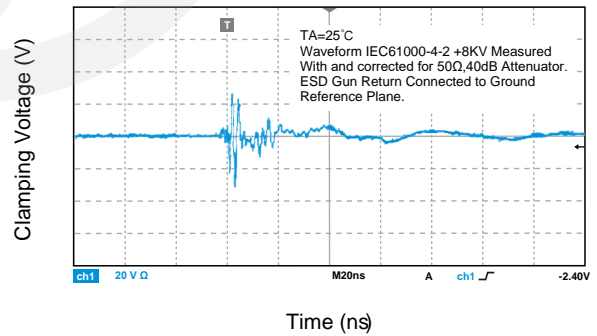
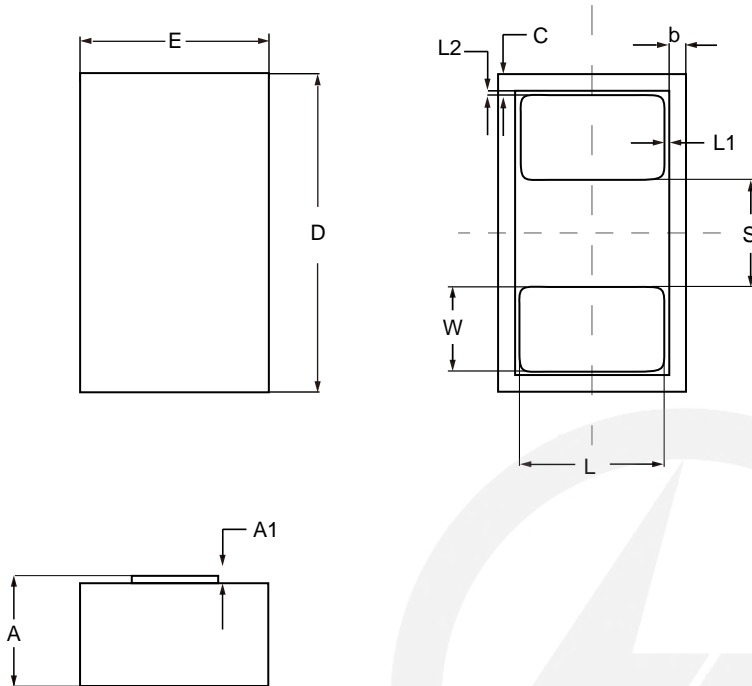

Fig.6 ESD Clamping of I/O to GND (-8kV Contact per IEC 61000-4-2)



CSP0603 Package Outline

Unit: mm



Symbol	Dimensions	
	NOM	Toler
A	0.202	± 0.0305
A1	0.011	± 0.003
D	0.600	± 0.025
E	0.300	± 0.025
W	0.1425	± 0.008
L	0.210	± 0.008
S	0.230	NA
L1	0.0075	NA
L2	0.005	NA
C	0.0375	NA
b	0.0375	NA

Reel Dimensions

Unit : mm

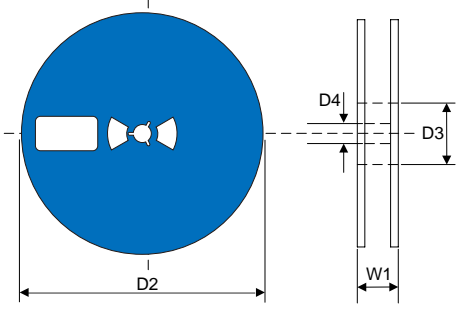
<p>7" Reel</p> 	D2	$\Phi 178.0 \pm 2.0$
	D3	$\Phi 50$
	D4	13.0 ± 0.5
	W1	12 ± 0.5
	Quantity: 10000PCS	

Packaging

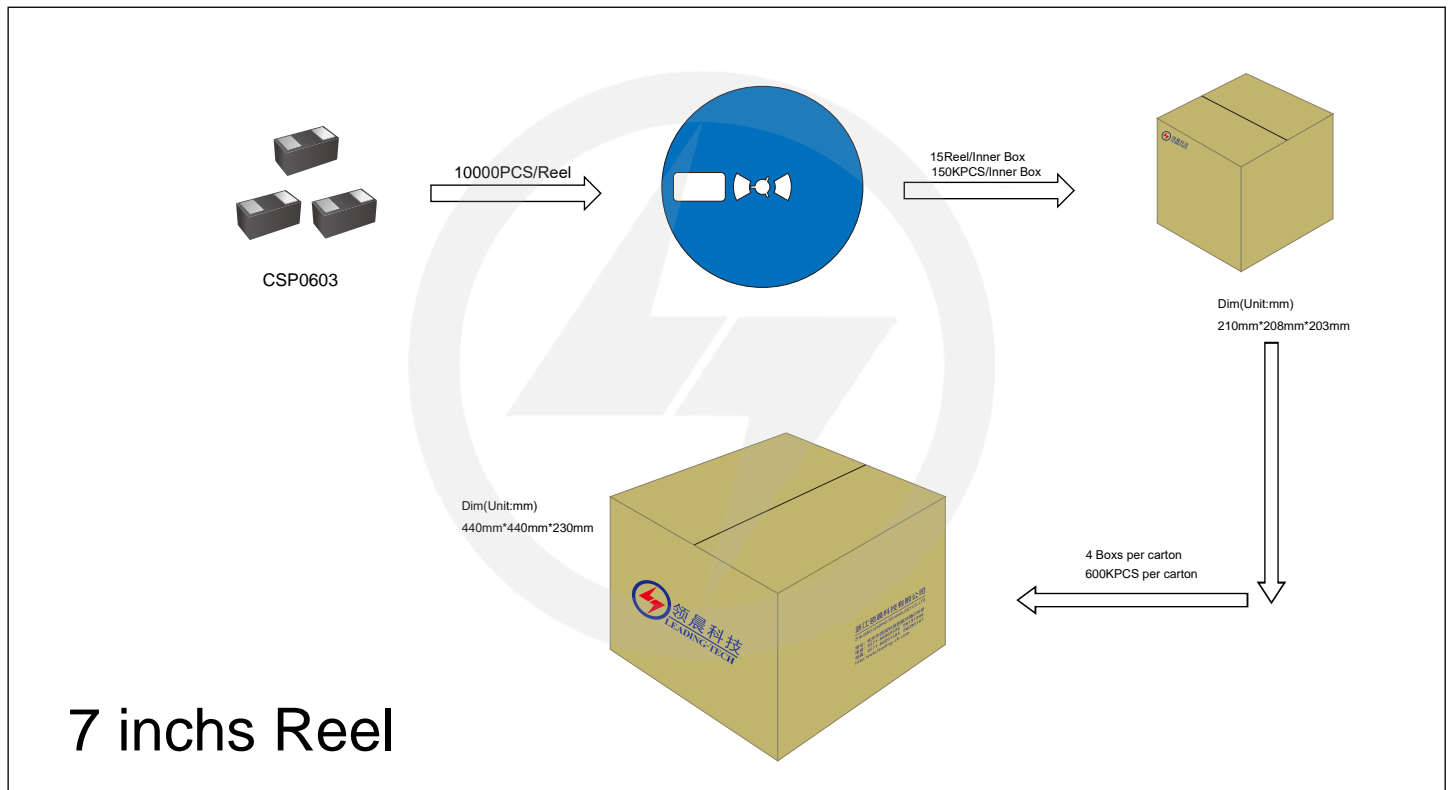



Recommended Soldering Conditions



Recommended Conditions

Profile Feature	Pb-Free Assembly
Average ramp-up rate (T _L to T _P)	3°C/second max.
Preheat	
-Temperature Min (T _{S min})	150°C
-Temperature Max (T _{S max})	200°C
-Time (min to max) (t _s)	60-180 seconds
T _{S max} to T _L	
-Ramp-up Rate	3°C/second max.
Time maintained above:	
-Temperature (T _L)	217°C
-Time (t _L)	60-150 seconds
Peak Temperature (T _P)	260°C
Time within 5°C of actual Peak Temperature (t _p)	20-40 seconds
Ramp-down Rate	6°C/second max.
Time 25°C to Peak Temperature	8 minutes max.

Important Notice and Disclaimer

Leading-Tech reserves the right to make changes to this document and its products and specifications at any time without notice.

Customers should obtain and confirm the latest product information and specifications before final design, purchase or use.

Leading-Tech makes no warranty, representation or guarantee regarding the suitability of its products for any particular purpose, not does Leading-Tech assume any liability for application assistance or customer product design.

Leading-tech does not warrant or accept any liability with products which are purchase or used for any unintended or unauthorized application.

No license is granted by implication or otherwise under any intellectual property rights of Leading-Tech.

Leading-Tech products are not authorized for use as critical components in life support devices or systems without express written approval of Leading-tech.

Version Update Information

Series NO.	Enactment/Revision Date	Effective Date	Version	Revision content	Revision Reason	Revision Person	Note
01	2024.03.16	2024.03.16	3.0	New File	/	Ding	